

Introduction

The nVent ERICO Cadweld Process

Cadweld connections are the accepted method of attaching Cathodic Protection leads to pipes (steel or cast iron), tanks and structures.

Cadweld connections weld the conductors and the structure to be protected so no galvanic corrosion can occur at the interface. The Cadweld process is specifically formulated to provide minimum heat effect on steel, which is especially important on thin-wall, high-stress pipes.

Cadweld connections are also used for header cable taps, conductor splices and terminations, and ground rod connections.

nVent Facts

A Cadweld Connection . . .

- Has current carrying capacity equal to that of the conductor.
- Is permanent with a low resistance connection that cannot loosen or corrode.
- Uses lightweight, inexpensive equipment.
- Requires no external source of power or heat.
- Requires no special skills.
- Can be easily checked for quality.

nVent is the pioneer of the Cadweld Exothermic Welding Process for permanent Cathodic Protection connections. Specifying the Cadweld Process in your construction plans will dramatically extend the lifespan of infrastructure systems.

Cadweld connections are made with a semi-permanent graphite mold, which holds the conductors to be welded. Weld metal (a mixture of copper oxide and aluminum) is dumped into the top of the mold. The mold is covered and the weld metal ignited. The exothermic reaction produces molten copper, which results in a permanent, high conductivity connection.

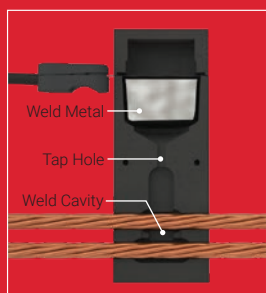

Cadweld Plus

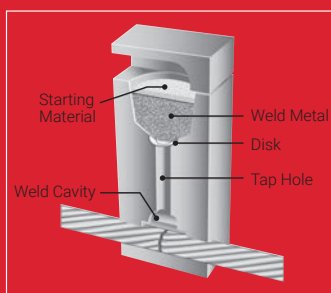

Traditional Cadweld

Table of Contents

INTRODUCTION	2
CONNECTIONS TO STEEL	3
Type CAHA.....	3
Type CAHC.....	4
Type CAVS	5
CONNECTIONS TO CAST IRON	6
Type CAVH.....	6
Type CAHB	7
Type CAHE.....	7
CONNECTIONS TO GROUND RODS	8
Type CAGR.....	8
Type CAGT	8
CONNECTIONS OF CABLE TO CABLE	9
Type CAPC.....	9
Type CASS	9
Type CATA.....	10
CONNECTIONS FOR STEEL ANODE WIRE	10
BONDS	11
Bonding Straps for Pipe Thawing.....	11
“Punched Strap” Bond for Steel Pipe	12
Formed Terminal	13
Welders for Formed Terminal Bonds.....	13
Formed Terminal with Pigtails	14
WELDERS AND MOLDS	15
WELD METAL	15
TOOLS AND MATERIALS	16
TECHNICAL INFORMATION	19
Piping Code.....	19
Cadweld Connections and Pipe Wall Thickness	20
Ductile Iron.....	20
CROSS REFERENCE	21
CADWELD APPLICATIONS	22

Connections to Steel

TYPE CAHA

Tap conductor to top of horizontal STEEL pipe or flat surface.

Note: For DUCTILE IRON, see page 20.

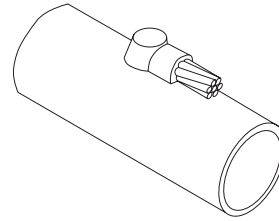

CAHA - Cable to Horizontal Steel Pipe

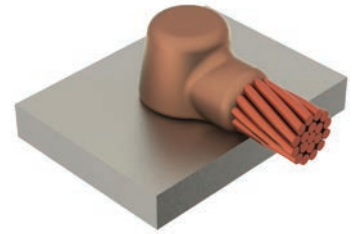

CAHA - Cable on surface

Conductor Size	Surface	Mold Part Number†	Mold Price Key	Traditional Cadweld Weld Metal	Cadweld Plus Weld Metal
#14 to #10 Solid (use sleeve CAB1331H)* or #8 Solid or Stranded, or #6 Solid	Flat (4" & larger pipe) 3/4" to 3-1/2" pipe	CAHAA1G	CAA	CA15	CA15PLUSF33
		CAHAA1GA	CAA	CA15	CA15PLUSF33
6 Stranded	Flat (4" & larger pipe) 3/4" to 3-1/2" pipe	CAHAA1H	CAA	CA15	CA15PLUSF33
		CAHAA1HA	CAA	CA15	CA15PLUSF33
4 Solid	Flat (6" & larger pipe) 3/4" to 3-1/2" pipe 4" to 5" pipe	CAHAA1K	CAA	CA15	CA15PLUSF33
		CAHAA1KA	CAA	CA15	CA15PLUSF33
		CAHAA1KB	CAA	CA15	CA15PLUSF33
4 Stranded	Flat (6" & larger pipe) 3/4" to 3-1/2" pipe 4" to 5" pipe	CAHAA1L	CAA	CA15	CA15PLUSF33
		CAHAA1LA	CAA	CA15	CA15PLUSF33
		CAHAA1LB	CAA	CA15	CA15PLUSF33
2 Solid	Flat (10" & larger pipe) 1" to 3-1/2" pipe 4" to 8" pipe	CAHAA1T	CAA	CA25	CA25PLUSF33
		CAHAA1TA	CAA	CA25	CA25PLUSF33
		CAHAA1TB	CAA	CA25	CA25PLUSF33
2 Stranded	Flat (16" & larger pipe) 1" to 3-1/2" pipe 4" to 8" pipe 10" to 14" pipe	CAHAA1V	CAA	CA32	CA32PLUSF33
		CAHAA1VA	CAA	CA32	CA32PLUSF33
		CAHAA1VB	CAA	CA32	CA32PLUSF33
		CAHAA1VC	CAA	CA32	CA32PLUSF33
1 Stranded	Flat (16" & larger pipe) 1-1/2" to 3-1/2" pipe 4" to 8" pipe 10" to 14" pipe	CAHAA1Y	CAA	CA45	CA45PLUSF33
		CAHAA1YA	CAA	CA45	CA45PLUSF33
		CAHAA1YB	CAA	CA45	CA45PLUSF33
		CAHAA1YC	CAA	CA45	CA45PLUSF33
1/0 Stranded	Flat (20" & larger pipe) 2-1/2" to 3-1/2" pipe 4" to 8" pipe 10" to 18" pipe	CAHAA2C	CAA	CA65	CA65PLUSF33
		CAHAA2CA	CAA	CA65	CA65PLUSF33
		CAHAA2CB	CAA	CA65	CA65PLUSF33
		CAHAA2CC	CAA	CA65	CA65PLUSF33
2/0 Stranded	Flat (20" & larger pipe) 2-1/2" to 3-1/2" pipe 4" to 8" pipe 10" to 18" pipe	CAHAA2G	CAA	CA65	CA65PLUSF33
		CAHAA2GA	CAA	CA65	CA65PLUSF33
		CAHAA2GB	CAA	CA65	CA65PLUSF33
		CAHAA2GC	CAA	CA65	CA65PLUSF33

* 1 sleeve per connection.

† Mold part number includes mold frame.

Connections to Steel

TYPE CAHC

Through conductor to top of horizontal STEEL pipe or flat surface.

NOTE: For DUCTILE IRON, see page 20.

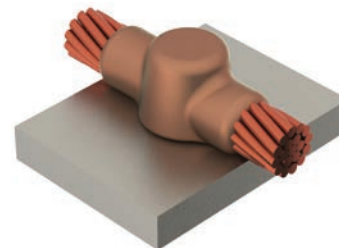

CAHC – Cable on surface

Conductor Size	Surface	Mold Part Number†	Mold Price Key	Traditional Cadweld Weld Metal	Cadweld Plus Weld Metal
#14 to #10 Solid (use sleeve CAB1331H)* or #8 Solid or Stranded or #6 Solid	Flat (12" & larger pipe)	CAHCA1G	CAA	CA25	CA25PLUSF33
	3/4" to 2" pipe	CAHCA1GA	CAA	CA25	CA25PLUSF33
	2-1/2" to 5" pipe	CAHCA1GB	CAA	CA25	CA25PLUSF33
	6" to 10" pipe	CAHCA1GC	CAA	CA25	CA25PLUSF33
6 Stranded	Flat (12" & larger pipe)	CAHCA1H	CAA	CA25	CA25PLUSF33
	3/4" to 2" pipe	CAHCA1HA	CAA	CA25	CA25PLUSF33
	2-1/2" to 5" pipe	CAHCA1HB	CAA	CA25	CA25PLUSF33
	6" to 10" pipe	CAHCA1HC	CAA	CA25	CA25PLUSF33
4 Solid	Flat (12" & larger pipe)	CAHCA1K	CAA	CA25	CA25PLUSF33
	3/4" to 2" pipe	CAHCA1KA	CAA	CA25	CA25PLUSF33
	2-1/2" to 5" pipe	CAHCA1KB	CAA	CA25	CA25PLUSF33
	6" to 10" pipe	CAHCA1KC	CAA	CA25	CA25PLUSF33
4 Stranded	Flat (12" & larger pipe)	CAHCA1L	CAA	CA25	CA25PLUSF33
	3/4" to 2" pipe	CAHCA1LA	CAA	CA25	CA25PLUSF33
	2-1/2" to 5" pipe	CAHCA1LB	CAA	CA25	CA25PLUSF33
	6" to 10" pipe	CAHCA1LC	CAA	CA25	CA25PLUSF33
2 Solid	Flat (14" & larger pipe)	CAHCA1T	CAA	CA32	CA32PLUSF33
	2" to 3-1/2" pipe	CAHCA1TA	CAA	CA32	CA32PLUSF33
	4" to 6" pipe	CAHCA1TB	CAA	CA32	CA32PLUSF33
	8" to 10" pipe	CAHCA1TC	CAA	CA32	CA32PLUSF33
2 Stranded	Flat (18" & larger pipe)	CAHCA1V	CAA	CA45	CA45PLUSF33
	2" to 3-1/2" pipe	CAHCA1VA	CAA	CA45	CA45PLUSF33
	4" to 8" pipe	CAHCA1VB	CAA	CA45	CA45PLUSF33
	10" to 16" pipe	CAHCA1VC	CAA	CA45	CA45PLUSF33
1 Stranded	Flat (18" & larger pipe)	CAHCA1Y	CAA	CA45	CA45PLUSF33
	2" to 3-1/2" pipe	CAHCA1YA	CAA	CA45	CA45PLUSF33
	4" to 8" pipe	CAHCA1YB	CAA	CA45	CA45PLUSF33
	10" to 16" pipe	CAHCA1YC	CAA	CA45	CA45PLUSF33
1/0 Stranded	Flat (30" & larger pipe)	CAHCA2C	CAA	CA65	CA65PLUSF33
	3" to 4" pipe	CAHCA2CA	CAA	CA65	CA65PLUSF33
	5" to 6" pipe	CAHCA2CB	CAA	CA65	CA65PLUSF33
	8" to 10" pipe	CAHCA2CC	CAA	CA65	CA65PLUSF33
2/0 Stranded	Flat (30" & larger pipe)	CAHCA2G	CAA	CA65	CA65PLUSF33
	3" to 4" pipe	CAHCA2GA	CAA	CA65	CA65PLUSF33
	5" to 6" pipe	CAHCA2GB	CAA	CA65	CA65PLUSF33
	8" to 10" pipe	CAHCA2GC	CAA	CA65	CA65PLUSF33
	12" to 28" pipe	CAHCA2GD	CAA	CA65	CA65PLUSF33

* 2 sleeves per connection.

† Mold part number includes mold frame.

Connections to Steel

TYPE CAVS

Tap conductor to vertical STEEL pipe or flat surface.

NOTE: For DUCTILE IRON, see page 20.

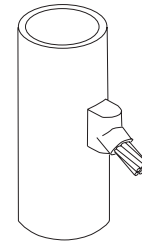

CAVS – Cable on surface

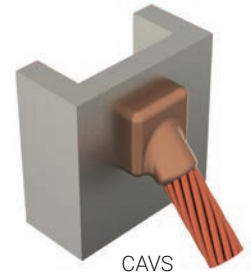

CAVS

Conductor Size	Surface	Mold Part Number†	Mold Price Key	Traditional Cadweld Weld Metal	Cadweld Plus Weld Metal
#14 to #10 Solid (use sleeve CAB1331H)* or #8 Solid or Stranded, or #6 Solid	Flat (12" & larger pipe) 3/4" to 3-1/2" pipe 4" to 10" pipe	CAVST1G	CAT	CA15	CA15PLUSF33
		CAVST1GA	CAT	CA15	CA15PLUSF33
		CAVST1GB	CAT	CA15	CA15PLUSF33
6 Stranded	Flat (12" & larger pipe) 3/4" to 3-1/2" pipe 4" to 10" pipe	CAVST1H	CAT	CA15	CA15PLUSF33
		CAVST1HA	CAT	CA15	CA15PLUSF33
		CAVST1HB	CAT	CA15	CA15 PLUSF33
4 Solid	Flat (12" & larger pipe) 3/4" to 1-1/2" pipe 2" to 4" pipe 5" to 10" pipe	CAVST1K	CAT	CA25	CA25PLUSF33
		CAVST1KA	CAT	CA25	CA25PLUSF33
		CAVST1KB	CAT	CA25	CA25PLUSF33
		CAVST1KC	CAT	CA25	CA25PLUSF33
4 Stranded	Flat (12" & larger pipe) 3/4" to 1-1/2" pipe 2" to 4" pipe 5" to 10" pipe	CAVST1L	CAT	CA25	CA25PLUSF33
		CAVST1LA	CAT	CA25	CA25PLUSF33
		CAVST1LB	CAT	CA25	CA25PLUSF33
		CAVST1LC	CAT	CA25	CA25PLUSF33
2 Solid	Flat (14" & larger pipe) 1" to 1-1/2" pipe 2" to 4" pipe 5" to 12" pipe	CAVST1T	CAT	CA25	CA25PLUSF33
		CAVST1TA	CAT	CA25	CA25PLUSF33
		CAVST1TB	CAT	CA25	CA25PLUSF33
		CAVST1TC	CAT	CA25	CA25PLUSF33
2 Stranded	Flat (14" & larger pipe) 1" to 1-1/2" pipe 2" to 3" pipe 4" to 8" pipe 8" to 12" pipe	CAVST1V	CAT	CA32	CA32PLUSF33
		CAVST1VA	CAT	CA32	CA32PLUSF33
		CAVST1VB	CAT	CA32	CA32PLUSF33
		CAVST1VC	CAT	CA32	CA32PLUSF33
		CAVST1VD	CAT	CA32	CA32PLUSF33
1 Stranded	Flat (18" & larger pipe) 1-1/2" to 2-1/2" pipe 3" to 4" pipe 5" to 10" pipe 12" to 16" pipe	CAVSP1Y	CAP	CA45	CA45PLUSF33
		CAVSP1YA	CAP	CA45	CA45PLUSF33
		CAVSP1YB	CAP	CA45	CA45PLUSF33
		CAVSP1YC	CAP	CA45	CA45PLUSF33
		CAVSP1YD	CAP	CA45	CA45PLUSF33
1/0 Stranded	Flat (18" & larger pipe) 2-1/2" to 4" pipe 5" to 10" pipe 12" to 16" pipe	CAVSP2C	CAP	CA65	CA65PLUSF33
		CAVSP2CA	CAP	CA65	CA65PLUSF33
		CAVSP2CB	CAP	CA65	CA65PLUSF33
		CAVSP2CC	CAP	CA65	CA65PLUSF33
2/0 Stranded	Flat (18" & larger pipe) 3" to 4" pipe 5" to 10" pipe 12" to 16" pipe	CAVSP2G	CAP	CA65	CA65PLUSF33
		CAVSP2GA	CAP	CA65	CA65PLUSF33
		CAVSP2GB	CAP	CA65	CA65PLUSF33
		CAVSP2GC	CAP	CA65	CA65PLUSF33

* 1 sleeve per connection.

† Mold part number includes mold frame.

Connections to Cast Iron

TYPE CAVH

Type CAVH Tap conductor to vertical CAST IRON pipe or flat surface.

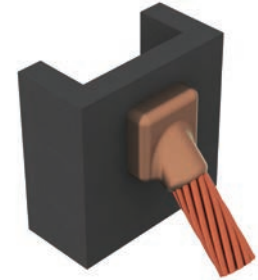

CAVH

Conductor Size	Surface	Mold Part Number†	Mold Price Key	Traditional Cadweld Weld Metal	Cadweld Plus Weld Metal
#14 to #10 Solid (use sleeve CAB1331H)** or #8 Solid or Stranded, or #6 Solid	Flat (30" & larger pipe) 4" to 24" pipe	CAVHT1G CAVHT1G.P.S.*	CAT CAT	CA25XF19 CA25XF19	CA25PLUSXF19 CA25PLUSXF19
6 Stranded	Flat (30" & larger pipe) 4" to 24" pipe	CAVHT1H CAVHT1H.P.S.*	CAT CAT	CA25XF19 CA25XF19	CA25PLUSXF19 CA25PLUSXF19
4 Solid	Flat (30" & larger pipe) 4" to 24" pipe	CAVHT1K CAVHT1K.P.S.*	CAT CAT	CA32XF19 CA32XF19	CA32PLUSXF19 CA32PLUSXF19
4 Stranded	Flat (30" & larger pipe) 4" to 24" pipe	CAVHT1L CAVHT1L.P.S.*	CAT CAT	CA32XF19 CA32XF19	CA32PLUSXF19 CA32PLUSXF19
2 Solid	Flat (30" & larger pipe) 4" to 24" pipe	CAVHP1T CAVHP1T.P.S.*	CAP CAP	CA45XF19 CA45XF19	CA45PLUSXF19 CA45PLUSXF19
2 Stranded	Flat (30" & larger pipe) 4" to 24" pipe	CAVHP1V CAVHP1V.P.S.*	CAP CAP	CA45XF19 CA45XF19	CA45PLUSXF19 CA45PLUSXF19
1 Stranded	Flat (36" & larger pipe) 4" to 30" pipe	CAVHP1Y CAVHP1Y.P.S.*	CAP CAP	CA65XF19 CA65XF19	CA65PLUSXF19 CA65PLUSXF19

* Specify pipe size. Example: For #2 stranded to 6" pipe, CAVHP1V6.

** 1 sleeve per connection.

† Mold part number includes mold frame.

Connections to Cast Iron

TYPE CAHB

Type CAHB Tap conductor to top of horizontal CAST IRON pipe or flat surface.

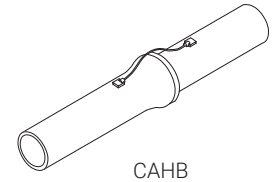

Conductor Size	Surface	Mold Part Number [†]	Mold Price Key	Traditional Cadweld Weld Metal	Cadweld Plus Weld Metal
#14 to #10 Solid (use sleeve CAB1331H)** or #8 Solid or Stranded, or #6 Solid	Flat (30" & larger pipe) 4" to 24" pipe	CAHBA1G	CAA	CA25XF19	CA25PLUSXF19
		CAHBA1GPS.*	CAA	CA25XF19	CA25PLUSXF19
6 Stranded	Flat (30" & larger pipe) 4" to 24" pipe	CAHBA1H	CAA	CA25XF19	CA25PLUSXF19
		CAHBA1HPS.*	CAA	CA25XF19	CA25PLUSXF19
4 Solid	Flat (30" & larger pipe) 4" to 24" pipe	CAHBA1K	CAA	CA45XF19	CA45PLUSXF19
		CAHBA1KPS.*	CAA	CA45XF19	CA45PLUSXF19
4 Stranded	Flat (30" & larger pipe) 4" to 24" pipe	CAHBA1L	CAA	CA45XF19	CA45PLUSXF19
		CAHBA1LPS.*	CAA	CA45XF19	CA45PLUSXF19
2 Solid	Flat (30" & larger pipe) 4" to 24" pipe	CAHBA1T	CAA	CA45XF19	CA45PLUSXF19
		CAHBA1TPS.*	CAA	CA45XF19	CA45PLUSXF19
2 Stranded	Flat (30" & larger pipe) 4" to 24" pipe	CAHBA1V	CAA	CA45XF19	CA45PLUSXF19
		CAHBA1VPS.*	CAA	CA45XF19	CA45PLUSXF19
1 Stranded	Flat (30" & larger pipe) 4" to 24" pipe	CAHBA1Y	CAA	CA65XF19	CA65PLUSXF19
		CAHBA1YPS.*	CAA	CA65XF19	CA65PLUSXF19

* Specify pipe size. Example: For #2 stranded to 6" pipe. (Type CAHB) CAHBA1V6, (Type CAHE) CAHEA1V6.

** 1 Sleeve per connection for Type CAHB. 2 Sleeves per connection for Type CAHE.

† Mold part number includes mold frame.

TYPE CAHE

Type CAHE Through conductor to top of horizontal CAST IRON pipe or flat surface.

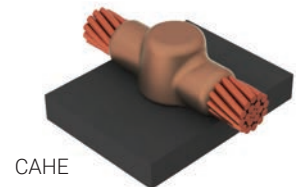

Conductor Size	Surface	Mold Part Number [†]	Mold Price Key	Traditional Cadweld Weld Metal	Cadweld Plus Weld Metal
#14 to #10 Solid (use sleeve CAB1331H)** or #8 Solid or Stranded, or #6 Solid	Flat (30" & larger pipe) 4" to 24" pipe	CAHEA1G	CAA	CA32XF19	CA32PLUSXF19
		CAHEA1GPS.*	CAA	CA32XF19	CA32PLUSXF19
6 Stranded	Flat (30" & larger pipe) 4" to 24" pipe	CAHEA1H	CAA	CA32XF19	CA32PLUSXF19
		CAHEA1HPS.*	CAA	CA32XF19	CA32PLUSXF19
4 Solid	Flat (30" & larger pipe) 4" to 24" pipe	CAHEA1K	CAA	CA45XF19	CA45PLUSXF19
		CAHEA1KPS.*	CAA	CA45XF19	CA45PLUSXF19
4 Stranded	Flat (30" & larger pipe) 4" to 24" pipe	CAHEA1L	CAA	CA45XF19	CA45PLUSXF19
		CAHEA1LPS.*	CAA	CA45XF19	CA45PLUSXF19
2 Solid	Flat (30" & larger pipe) 4" to 24" pipe	CAHEA1T	CAA	CA45XF19	CA45PLUSXF19
		CAHEA1TPS.*	CAA	CA45XF19	CA45PLUSXF19
2 Stranded	Flat (30" & larger pipe) 4" to 24" pipe	CAHEA1V	CAA	CA45XF19	CA45PLUSXF19
		CAHEA1VPS.*	CAA	CA45XF19	CA45PLUSXF19
1 Stranded	Flat (30" & larger pipe) 4" to 24" pipe	CAHEA1Y	CAA	CA65XF19	CA65PLUSXF19
		CAHEA1YPS.*	CAA	CA65XF19	CA65PLUSXF19

* Specify pipe size. Example: For #2 stranded to 6" pipe. (Type CAHB) CAHBA1V6, (Type CAHE) CAHEA1V6.

** 1 Sleeve per connection for Type CAHB. 2 Sleeves per connection for Type CAHE.

† Mold part number includes mold frame.

Do not use Types CAHB, CAHE, or CAVH on soil pipe (ASTM A74-82)

A test weld should be made on a section of the pipe being used to determine possibility of detrimental metallurgical effects. For DUCTILE IRON, see page 20.

Connections to Ground Rods

TYPE CAGR & CAGT



Ground Rod Size ¹	Conductor Size	STYLE GR				STYLE GT			
		Mold Part Number [†]	Mold Price Key	Traditional Cadweld Weld Metal	Cadweld Plus Weld Metal	Mold Part Number [†]	Mold Price Key	Traditional Cadweld Weld Metal	Cadweld Plus Weld Metal
Nominal 1/2" (Actual .475 Dia.)	#14 to #10 Solid (use sleeve CAB1331H)* or #8 Solid or Stranded, or #6 Solid	CAGRT151G	CAT	CA25	CA25PLUSF33	CAGTT151G	CAT	CA32	CA32PLUSF33
	6 Stranded	CAGRT151H	CAT	CA25	CA25PLUSF33	CAGTT151H	CAT	CA32	CA32PLUSF33
	4 Solid	CAGRT151K	CAT	CA25	CA25PLUSF33	CAGTT151K	CAT	CA32	CA32PLUSF33
	4 Stranded	CAGRT151L	CAT	CA25	CA25PLUSF33	CAGTT151L	CAT	CA32	CA32PLUSF33
	2 Solid	CAGRT151T	CAT	CA32	CA32PLUSF33	CAGTP151T	CAP	CA45	CA45PLUSF33
	2 Stranded	CAGRT151V	CAT	CA32	CA32PLUSF33	CAGTP151V	CAP	CA45	CA45PLUSF33
	1 Stranded	CAGRP151Y	CAP	CA45	CA45PLUSF33	CAGTP151Y	CAP	CA65	CA65PLUSF33
	1/0 Stranded	CAGRP152C	CAP	CA65	CA65PLUSF33	CAGTP152C	CAP	CA65	CA65PLUSF33
	2/0 Stranded	CAGRP152G	CAP	CA65	CA65PLUSF33	CAGTP152G	CAP	CA65	CA65PLUSF33
Nominal 5/8" (Actual .563 Dia.)	#14 to #10 Solid (use sleeve CAB1331H)* or #8 Solid or Stranded, or #6 Solid	CAGRT161G	CAT	CA32	CA32PLUSF33	CAGTP161G	CAP	CA45	CA45PLUSF33
	6 Stranded	CAGRT161H	CAT	CA32	CA32PLUSF33	CAGTP161H	CAP	CA45	CA45PLUSF33
	4 Solid	CAGRT161K	CAT	CA32	CA32PLUSF33	CAGTP161K	CAP	CA65	CA65PLUSF33
	4 Stranded	CAGRT161L	CAT	CA32	CA32PLUSF33	CAGTP161L	CAP	CA65	CA65PLUSF33
	2 Solid	CAGRP161T	CAP	CA45	CA45PLUSF33	CAGTP161T	CAP	CA65	CA65PLUSF33
	2 Stranded	CAGRP161V	CAP	CA45	CA45PLUSF33	CAGTP161V	CAP	CA65	CA65PLUSF33
	1 Stranded	CAGRP161Y	CAP	CA45	CA45PLUSF33	CAGTP161Y	CAP	CA65	CA65PLUSF33
	1/0 Stranded	CAGRP162C	CAP	CA65	CA65PLUSF33	CAGTN162C	CAN	2-CA45	N/A
	2/0 Stranded	CAGRP162G	CAP	CA65	CA65PLUSF33	CAGTN162G	CAN	2-CA45	N/A
Nominal 3/4" (Actual .682 Dia.)	#14 to #10 Solid (use sleeve CAB1331H)* or #8 Solid or Stranded, or #6 Solid	CAGRT181G	CAT	CA32	CA32PLUSF33	CAGTP181G	CAP	CA45	CA45PLUSF33
	6 Stranded	CAGRT181H	CAT	CA32	CA32PLUSF33	CAGTP181H	CAP	CA45	CA45PLUSF33
	4 Solid	CAGRP181K	CAP	CA45	CA45PLUSF33	CAGTP181K	CAP	CA65	CA65PLUSF33
	4 Stranded	CAGRP181L	CAP	CA45	CA45PLUSF33	CAGTP181L	CAP	CA65	CA65PLUSF33
	2 Solid	CAGRP181T	CAP	CA45	CA45PLUSF33	CAGTP181T	CAP	CA65	CA65PLUSF33
	2 Stranded	CAGRP181V	CAP	CA45	CA45PLUSF33	CAGTP181V	CAP	CA65	CA65PLUSF33
	1 Stranded	CAGRP181Y	CAP	CA45	CA45PLUSF33	CAGTP181Y	CAP	CA65	CA65PLUSF33
	1/0 Stranded	CAGRP182C	CAP	CA65	CA65PLUSF33	CAGTN182C	CAN	2-CA45	N/A
	2/0 Stranded	CAGRP182G	CAP	CA65	CA65PLUSF33	CAGTN182G	CAN	2-CA45	N/A

¹ For plain (unthreaded) copper-clad ground rods only. For threaded copper-clad rods or for steel rods, contact nVent for part number.

[†] Mold part number includes mold frame.

* 1 sleeve per GR connection. 2 sleeves per GT connection.

Connections of Cable to Cable

TYPE CAPC

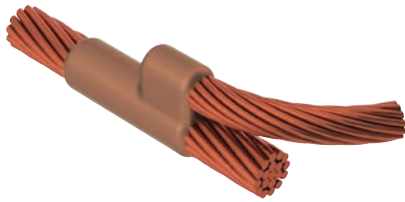

Type CAPC
Tap cable to a through cable.
Also see Type CATA, page 10

Conductor Size*		Mold Part Number†	Mold Price Key	Traditional Cadweld Weld Metal	Cadweld Plus Weld Metal
Run	Tap				
6 Stranded	6 Stranded	CAPCT1H1H	CAT	CA25	CA25PLUSF33
	6 Solid	CAPCT1H1G	CAT	CA25	CA25PLUSF33
	8 Stranded	CAPCT1H1E	CAT	CA25	CA25PLUSF33
	8 Solid	CAPCT1H1D	CAT	CA25	CA25PLUSF33
4 Stranded	4 Stranded	CAPCT1L1L	CAT	CA32	CA32PLUSF33
	6 Stranded	CAPCT1L1H	CAT	CA32	CA32PLUSF33
	6 Solid	CAPCT1L1G	CAT	CA32	CA32PLUSF33
	8 Stranded	CAPCT1L1E	CAT	CA32	CA32PLUSF33
	8 Solid	CAPCT1L1D	CAT	CA32	CA32PLUSF33
2 Stranded	2 Stranded	CAPCP1V1V	CAP	CA65	CA65PLUSF33
	4 Stranded	CAPCP1V1L	CAP	CA45	CA45PLUSF33
	6 Stranded	CAPCT1V1H	CAT	CA32	CA32PLUSF33
	6 Solid	CAPCT1V1G	CAT	CA32	CA32PLUSF33
	8 Stranded	CAPCT1V1E	CAT	CA32	CA32PLUSF33
	8 Solid	CAPCT1V1D	CAT	CA32	CA32PLUSF33
1 Stranded	2 Stranded	CAPCP1Y1V	CAP	CA65	CA65PLUSF33
	4 Stranded	CAPCP1Y1L	CAP	CA45	CA45PLUSF33
	6 Stranded	CAPCP1Y1H	CAP	CA45	CA45PLUSF33
	6 Solid	CAPCP1Y1G	CAP	CA45	CA45PLUSF33
	8 Stranded	CAPCP1Y1E	CAP	CA45	CA45PLUSF33
	8 Solid	CAPCP1Y1D	CAP	CA45	CA45PLUSF33
1/0 Stranded	2 Stranded	CAPCP2C1V	CAP	CA65	CA65PLUSF33
	4 Stranded	CAPCP2C1L	CAP	CA65	CA65PLUSF33
	6 Stranded	CAPCP2C1H	CAP	CA45	CA45PLUSF33
	6 Solid	CAPCP2C1G	CAP	CA45	CA45PLUSF33
	8 Stranded	CAPCP2C1E	CAP	CA45	CA45PLUSF33
	8 Solid	CAPCP2C1D	CAP	CA45	CA45PLUSF33
2/0 Stranded	2 Stranded	CAPCN2G1V	CAN	2-CA45	N/A
	4 Stranded	CAPCP2G1L	CAP	CA65	CA65PLUSF33
	6 Stranded	CAPCP2G1H	CAP	CA65	CA65PLUSF33
	6 Solid	CAPCP2G1G	CAP	CA65	CA65PLUSF33
	8 Stranded	CAPCP2G1E	CAP	CA65	CA65PLUSF33
	8 Solid	CAPCP2G1D	CAP	CA65	CA65PLUSF33

* For #10 Solid through #14 Tap, use sleeve CAB1331H on wire in welder for #6 Stranded Tap.

† Mold part number includes mold frame.

TYPE CASS

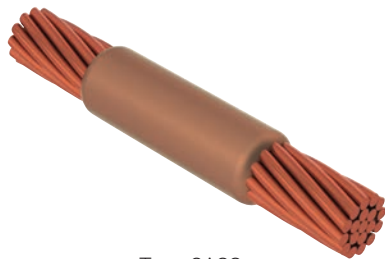

Type CASS
Splice of conductors.

Conductor Size	Mold Part Number†	Mold Price Key	Traditional Cadweld Weld Metal	Cadweld Plus Weld Metal
12 Solid	CASST001	CAT	CA15	CA15PLUSF33
10 Solid	CASST1A	CAT	CA15	CA15PLUSF33
8 Solid	CASST1D	CAT	CA15	CA15PLUSF33
6 Solid	CASST1G	CAT	CA25	CA25PLUSF33
6 Stranded	CASST1H	CAT	CA25	CA25PLUSF33
4 Solid	CASST1K	CAT	CA25	CA25PLUSF33
4 Stranded	CASST1L	CAT	CA25	CA25PLUSF33
2 Solid	CASST1T	CAT	CA32	CA32PLUSF33
2 Stranded	CASST1V	CAT	CA32	CA32PLUSF33
1 Stranded	CASST1Y	CAT	CA32	CA32PLUSF33
1/0 Stranded	CASSP2C	CAP	CA45	CA45PLUSF33
2/0 Stranded	CASSP2G	CAP	CA65	CA65PLUSF33

† Mold part number includes mold frame.

Connections of Cable to Cable

TYPE CATA

Type CATA connections are available for any combination of run and tap conductor sizes. For small size taps, the Type CAPC is recommended. Contact your local distributor or nVent for additional information.

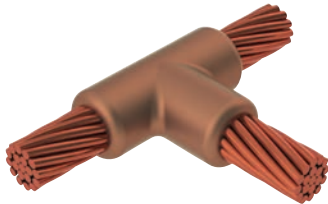

Concentric Strand Copper Cable

Cable Size		Mold Part Number	Mold Price Key	Traditional Cadweld Weld Metal	Cadweld Plus Weld Metal
Run	Tap				
2	2	CATAN1VIV	CAN	CA45	CA45PLUSF33
	4	CATAN1V1L	CAN	CA45	CA45PLUSF33
1	1	CATAN1Y1Y	CAN	CA45	CA45PLUSF33
	2	CATAN1Y1V	CAN	CA45	CA45PLUSF33
	4	CATAN1Y1L	CAN	CA45	CA45PLUSF33
1/0	1	CATAN2C1Y	CAN	CA45	CA45PLUSF33
	2	CATAN2C1V	CAN	CA45	CA45PLUSF33
	4	CATAN2C1L	CAN	CA45	CA45PLUSF33
2/0	1	CATAN2G1Y	CAN	CA45	CA45PLUSF33
	2	CATAN2G1V	CAN	CA45	CA45PLUSF33
	4	CATAN2G1L	CAN	CA45	CA45PLUSF33

Connections for Steel Anode Wire

Cadweld molds for use with steel anode wire available.

CASS

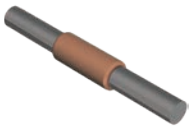

Mold Part Number	Run	Tap	Mold Price Key	Traditional Cadweld Welding Material	Cadweld Plus Welding Material
CASSP2G135	2/0 concentric	.135 diameter steel wire	CAP	CA45	CA45PLUSF33
CASST007	.135 diameter steel wire	.135 diameter steel wire	CAT	CA15	CA15PLUSF33
CASST1V002	#2 Stranded wire	.130 diameter steel wire	CAT	CA25	CA25PLUSF33
CASST1V001	#2 Stranded wire	.185 diameter steel wire	CAT	CA25	CA25PLUSF33
CASST1351A	.135 diameter steel wire	#10 solid/#12 stranded with two CAB1331H	CAT	CA25	CA25PLUSF33
CASST1351H	.135 diameter steel wire	#6 stranded wire	CAT	CA25	CA25PLUSF33

CAPG

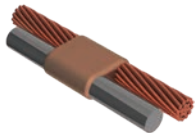

Mold Part Number	Run	Tap	Mold Price Key	Traditional Cadweld Welding Material	Cadweld Plus Welding Material
CAPGT1E003	#8 stranded wire	.135 diameter steel wire	CAT	CA25	CA25PLUSF33

CAPT

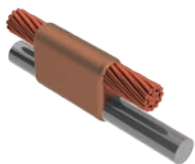

Mold Part Number	Run	Tap	Mold Price Key	Traditional Cadweld Welding Material	Cadweld Plus Welding Material
CAPTT002	.115 diameter steel wire	#8 stranded wire	CAT	CA25	CA25PLUSF33
CAPTT.1351E	.135 diameter steel wire	#8 stranded wire	CAT	CA25	CA25PLUSF33
CAPTC001	.135 diameter steel wire	#2 stranded wire	CAT	CA45	CA45PLUSF33

CATA

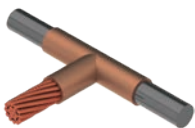

Mold Part Number	Run	Tap	Mold Price Key	Traditional Cadweld Welding Material	Cadweld Plus Welding Material
CATAP008	.130 diameter steel wire	.130 diameter steel wire	CAP	CA45	CA45PLUSF33
CATAP002	.135 diameter steel wire	.135 diameter steel wire	CAP	CA25	CA25PLUSF33

Bonds

BONDING STRAPS FOR PIPE THAWING

In colder climates, water distribution pipes occasionally freeze in the winter. To thaw the ice, a high current (for example, from a welding machine) is applied to heat the pipe and thaw the ice. To accomplish this, each pipe joint must be efficiently bonded to control the electrical path and to prevent burning the pipe gaskets. 3/4" wide copper bonding straps, welded to the pipe with Cadweld connections, provide the necessary bond or current path across the pipe joints. The bonding strips have been tested at over 500 amperes.

The straps may also be used to provide continuity for Cathodic protection or grounding systems.

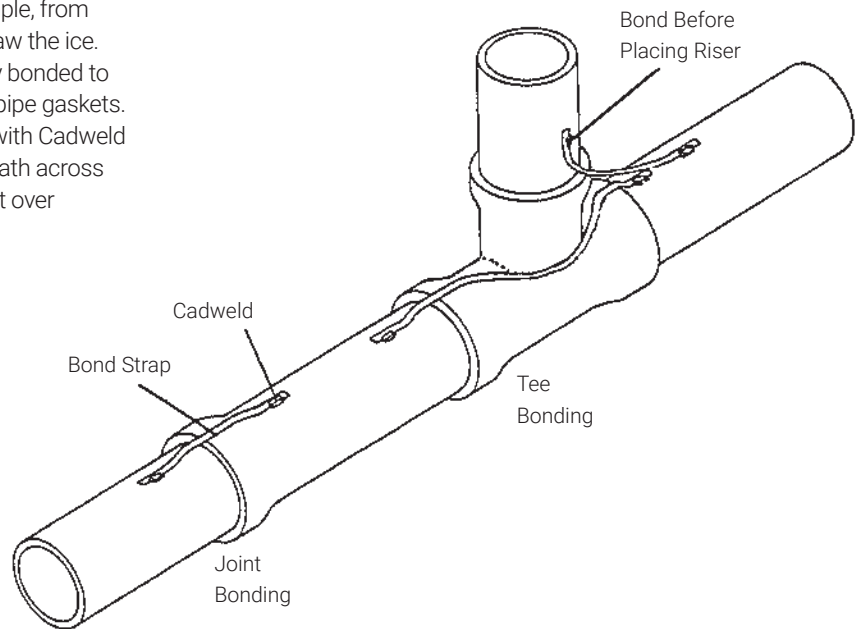

Straps

Size	Part No.
1/16" x 3/4"	CAA817A - "L"
1/16" x 1"	CAA817B - "L"

L = Length in inches

To Cast Iron or Ductile Iron Pipe

Pipe Size	1/16" x 3/4" Strap Mold Part No.†	1/16" x 1" Strap and Wider Mold Part No.†	Mold Price Key	Traditional Cadweld Weld Metal	Cadweld Plus Weld Metal
4" - 12"	CACHAADCA	CACHAAECA	CAA	CA32XF19	CA32PLUSXF19
14" - 30"	CACHAADCB	CACHAAECB	CAA	CA32XF19	CA32PLUSXF19
Over 30"	CACHAADC	CACHAAEC	CAA	CA32XF19	CA32PLUSXF19
As Specified #	CACHAADC(PS)*	CACHAAEC(PS)*	CAA	CA32XF19	CA32PLUSXF19

To Steel Pipe

Pipe Size	1/16" x 3/4" Strap Mold Part No.†	1/16" x 1" Strap and Wider Mold Part No.†	Mold Price Key	Traditional Cadweld Weld Metal	Cadweld Plus Weld Metal
4" - 12"	CACHAADSA	CACHAAESA	CAA	CA32	CA32PLUSF33
14" - 30"	CACHAADSB	CACHAAESB	CAA	CA32	CA32PLUSF33
Over 30"	CACHAADS	CACHAAES	CAA	CA32	CA32PLUSF33
As Specified #	CACHAADS(PS)*	CACHAAES(PS)*	CAA	CA32	CA32PLUSF33

† Mold part number includes mold frame.

When only one pipe size is involved, order mold to fit that pipe size.

* Add pipe size (PS).

Bonds

"PUNCHED STRAP" BOND FOR STEEL PIPE

The Cadweld "Punched Strap" Bond allows bonding across joints of steel pipe with a bond of approximately 1/0 AWG size using a CA15 Weld Metal. This allows larger size bonds on steel pressure pipe covered by ANSI/ASME B31. (See page 19).

The Punched Strap bond is fabricated from 1/16" x 1-1/4" soft copper, allowing easy hand forming over the pipe coupling.

The 5-hole model is used on "Dresser Type" pipe couplings with two welds to the pipe and three to the coupling, made through the holes.

A 2-hole model (the 'B' dimensions are zero) is used across standard mechanical joints or across "Dresser Type" joints when the coupling does not have to be bonded.

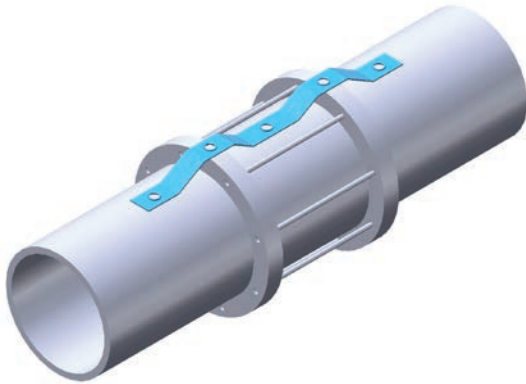

Cathodic Bonding Strap, 5 Holes

Part Number	Length L	Width W	Thickness T	Hole Size HS	A	B	C
CAB496A15B25	22"	1 1/4"	1/16"	1/2"	3 3/4"	6 1/4"	1"
CAB496A16B16	18"	1 1/4"	1/16"	1/2"	4"	4"	1"
CAB496A24B12	20"	1 1/4"	1/16"	1/2"	6"	3"	1"

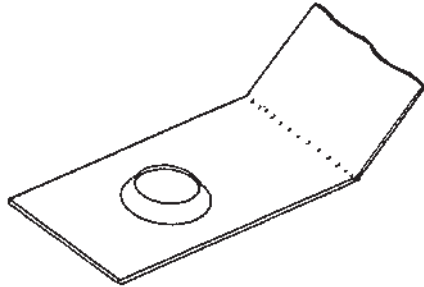
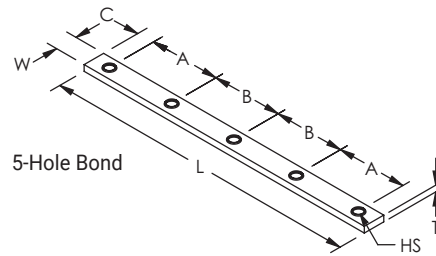

Cathodic Bonding Strap, 2 Holes

Part Number	Length L	Width W	Thickness T	Hole Size HS	A	B
CAB496A32B0	10"	1 1/4"	1/16"	1/2"	8"	1"
CAB496A36B0	11"	1 1/4"	1/16"	1/2"	9"	1"
CAB496A44B0	13"	1 1/4"	1/16"	1/2"	11"	1"
CAB496A64B0	18"	1 1/4"	1/16"	1/2"	16"	1"

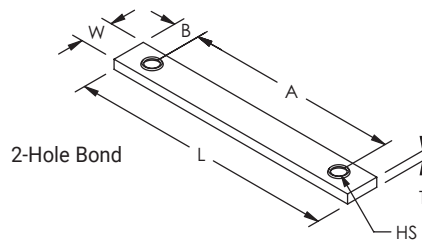

Ordering Information

A. BOND; CAB496A B
 "B" dimension } in fourths } 1-3/8"
 "A" dimension } of an inch } min.

Example: a) 5-hole bond

A = 3-3/4" (15 fourths); B = 6-1/4" (25 fourths)
 P/N CAB496A15B25

b) 2-hole bond

A = 16" (64 fourths); B = 0" (0 fourths)
 P/N CAB496A64B0

B. Cadweld Bond;

a) Mold with frame/Handle P/N CAHAAA F

b) Replacement Mold ONLY P/N CAHAAA FM

C. Cadweld Weld Metal;
 CA15

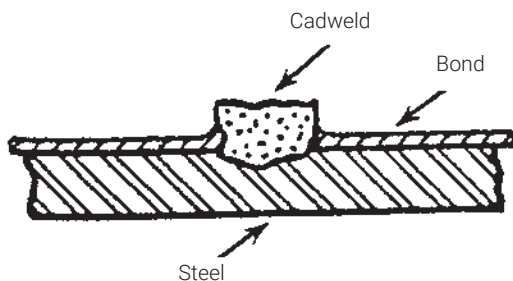

Bonds

FORMED TERMINAL

Factory made bonds

Bonds with terminals formed on the ends are often used for bonding pipe joints and fittings. The formed terminal allows a smaller weld metal size to be used.

Conductor Size	Insulated Bond Part No.	Bare Bond Part No.
#2	CAF11V – length in inches	CAF21V – length in inches
1/0	CAF12C – length in inches	CAF22C – length in inches
2/0	CAF12G – length in inches	CAF22G – length in inches



Field made bonds

Formed Terminal Bonds may be made in the field using sleeves (one per conductor end) and forming them in the hammer dies listed.

Conductor Size	Sleeve Part No.	Hammer Die Part No.
#4	CAS20F	JD11
#2	CAS09F	JD09
1/0	CAS05F	JD05
2/0	CAS03F	JD03

WELDERS FOR FORMED TERMINAL BONDS

Type CAFS Welders for Steel Pipe.

For DUCTILE IRON, see page 20.

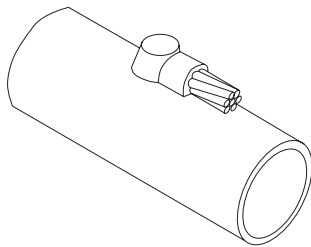

Conductor Size	Surface	Mold Part Number†	Mold Price Key	Traditional Cadweld Weld Metal	Cadweld Plus Weld Metal
#4	Flat (10" & larger pipe) 4" pipe 6 to 8" pipe	CAFSA1L	CAA	CA25	CA25PLUSF33
		CAFSA1LA	CAA	CA25	CA25PLUSF33
		CAFSA1LB	CAA	CA25	CA25PLUSF33
#2	Flat (10" & larger pipe) 4" pipe 6 to 8" pipe	CAFSA1V	CAA	CA25	CA25PLUSF33
		CAFSA1VA	CAA	CA25	CA25PLUSF33
		CAFSA1VB	CAA	CA25	CA25PLUSF33
1/0	Flat (12" & larger pipe) 4" pipe 6 to 10" pipe	CAFSA2C	CAA	CA32	CA32PLUSF33
		CAFSA2CA	CAA	CA32	CA32PLUSF33
		CAFSA2CB	CAA	CA32	CA32PLUSF33
2/0	Flat (12" & larger pipe) 4" pipe 6 to 10" pipe	CAFSA2G	CAA	CA45	CA45PLUSF33
		CAFSA2GA	CAA	CA45	CA45PLUSF33
		CAFSA2GB	CAA	CA45	CA45PLUSF33

* Indicate pipe size.

† Mold part number includes mold frame.

Type CAFC Welders for Cast Iron Pipe.

Do not use on soil pipe. (ASTM A74-82).

A test weld should be made on a section of the pipe being used to determine possibility of detrimental metallurgical effects.

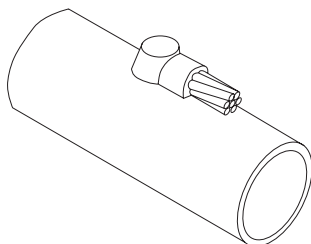

Conductor Size	Surface	Mold Part Number†	Mold Price Key	Traditional Cadweld Weld Metal	Cadweld Plus Weld Metal
#4	Flat (30" & larger pipe) 4" to 24" pipe	CAFCA1L	CAA	CA32XF19	CA32PLUSXF19
		CAFCA1LP.S*	CAA	CA32XF19	CA32PLUSXF19
#2	Flat (30" & larger pipe) 4" to 24" pipe	CAFCA1V	CAA	CA32XF19	CA32PLUSXF19
		CAFCA1VP.S*	CAA	CA32XF19	CA32PLUSXF19
1/0	Flat (30" & larger pipe) 4" to 24" pipe	CAFCA2C	CAA	CA45XF19	CA45PLUSXF19
		CAFCA2CPS.*	CAA	CA45XF19	CA45PLUSXF19
2/0	Flat (36" & larger pipe) 4" to 30" pipe	CAFCA2G	CAA	CA65XF19	CA65PLUSXF19
		CAFCA2GPS.*	CAA	CA65XF19	CA65PLUSXF19

* Indicate pipe size.

† Mold part number includes mold frame.

Bonds

FORMED TERMINAL WITH PIGTAILS

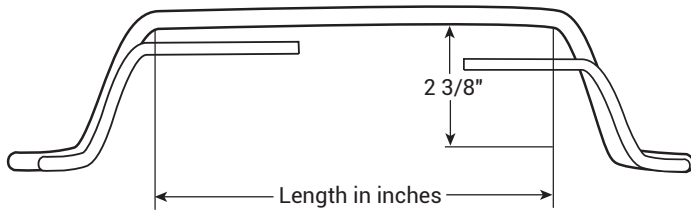

FACTORY MADE BONDS with Pigtails for "Dresser Type" Pipe Couplings

Insulated, formed terminal bonds with insulated pigtails are used to bond across the joint and to bond both the middle ring and follower ring of Dresser Type Couplings.

Conductor Size	Pigtail Size	Bond Part No.
#2	#12 Solid	CAD11V-length in inches
1/0	8 Solid	CAD12C-length in inches

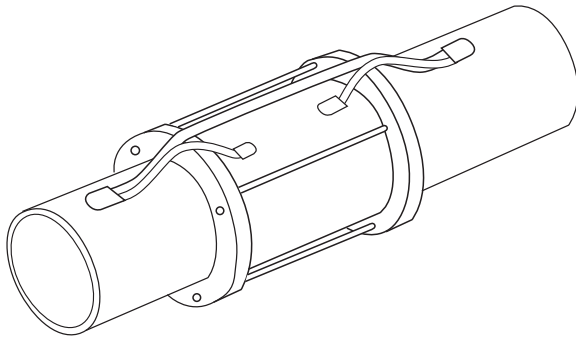

Type CADS Welders for Steel Pipe

Type DC Welders for CAST IRON Pipe

Do not use on soil pipe. (ASTM A-74-82).

A test weld should be made on a section of the pipe being used to determine possibility of detrimental metallurgical effects.

For DUCTILE IRON, See page 20.

Bond ¹	Pipe Size	Terminal Welder			Pigtail Welder			
		Mold Part Number [†]	Traditional Cadweld Weld Metal	Cadweld Plus Weld Metal	Mold Part Number [†]	Traditional Cadweld Weld Metal	Cadweld Plus Weld Metal	
TYPE CADS WELDERS FOR STEEL PIPE								
CAD11V (#2)	4" pipe	CADSA1VA	CA25	}	CA25PLUSF33	CAHAA1G	CA15	CA15PLUSF33
	6" to 8" pipe	CADSA1VB	CA25		CA25PLUSF33			
	10" & larger pipe	CADSA1V	CA25		CA25PLUSF33			
CAD12C (1/0)	4" pipe	CADSA2CA	CA32	}	CA32PLUSF33	CAHAA1D	CA15	CA15PLUSF33
	6" to 10" pipe	CADSA2CB	CA32		CA32PLUSF33			
	12" & larger pipe	CADSA2C	CA32		CA32PLUSF33			
TYPE CADS WELDERS FOR CAST IRON PIPE								
CAD11V (#2)	4 to 24" pipe	CADCA1VAPS.*	CA32XF19	}	CA32PLUSXF19	CAHBA1GPS.*	CA25XF19	CA25PLUSXF19
	30" & larger pipe	CADCA1V	CA32XF19		CA32PLUSXF19			
CAD12C (1/0)	4 to 24" pipe	CADCA2CPS.*	CA45XF19	}	CA45PLUSXF19	CAHBA1DPS.*	CA25XF19	CA25PLUSXF19
	30" & larger pipe	CADCA2C	CA45XF19		CA45PLUSXF19			

* Add pipe size. Example: CADCA1V12 for 12" pipe.

[†] Mold part number includes mold frame.

¹ For factory made bonds listed above.

Welders and Molds

Cadweld Welders And Molds

When making a Cadweld connection, an accurate control of the Cadweld process is accomplished by using a semi-permanent graphite mold. Control is exercised over the direction and speed of the molten Cadweld weld metal flow and final shape. The graphite used in a Cadweld mold is a high temperature type that lasts for an average of 50 to 100 Cadweld connections under normal usage.

* Mold part number includes mold frame.

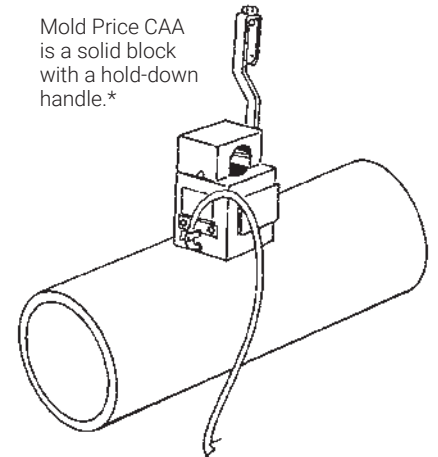
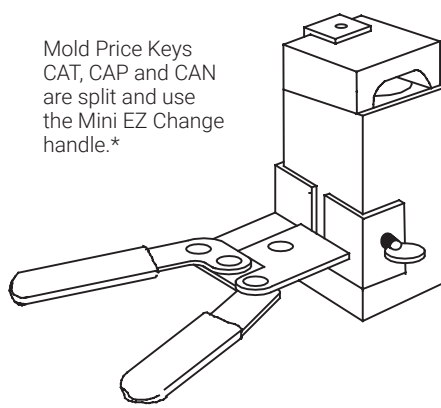

Weld Metal

Cadweld Weld Metal

Mixture consists mainly of copper oxide and aluminum. Specifically used in cathodic protection applications on cable to steel or stainless steel. Color coding by size for easy identification.

Two types of Cadweld weld metal are used for Cathodic protection connections:

1. F33 alloy is used for all connections of cable to cable and cable to steel or stainless steel pipe. The F33 weld metal containers have green caps.
2. XF19 alloy is used for all connections to cast iron. XF19 weld metal containers have orange caps.

Cadweld Plus Welding Material



Traditional Cadweld Welding Material



NOTE: For DUCTILE IRON, see page 20.

Cadweld Plus Welding Material	Box	Standard Pack
CA15PLUSF33	20	100
CA25PLUSF33	20	100
CA32PLUSF33	20	100
CA45PLUSF33	20	100
CA65PLUSF33	20	100
CA25PLUSXF19	20	100
CA32PLUSXF19	20	100
CA45PLUSXF19	20	100
CA65PLUSXF19	20	100

Traditional Cadweld Welding Material*	Box	Standard Pack
CA15	20	100
CA25	20	100
CA32	20	100
CA45	20	100
CA65	20	100
CA25XF19	20	100
CA32XF19	20	100
CA45XF19	20	100
CA65XF19	20	100

* Disks are included.

Tools and Materials



Mold Cleaner B136A

Mold Cleaners are useful for removing the slag from CAA molds after making a Cadweld connection.

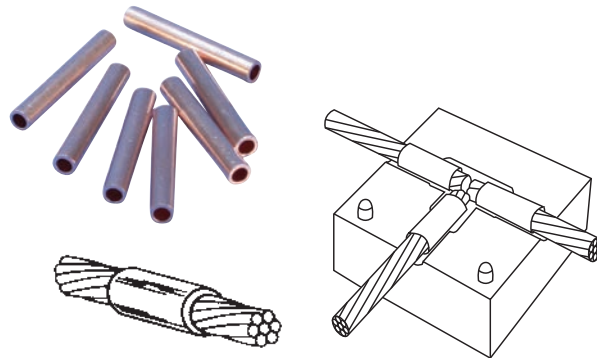

Adapter Sleeves

Small conductors may be built up to fit the opening of larger size welders using either adapter sleeves or shim stock.



Torch Head T111

Self-igniting propane torch head. Squeeze the control knob for an instant flame. Release and it's out. No flame adjusting. And, the burn tip remains cool during normal use. Operates on its side or upside down. Can withstand 60-MPH winds without flareout. Saves fuel. Safer to use. Fits all standard 14 and 16 oz. propane cylinders.

Cable Size		Use Adapter Sleeve Part No.	Use in Mold for Conductor Size	
Stranded	Solid		Stranded	Solid
#12, 14	#10, 12, 14	CAB1331H	#6	#6
10	8, 10	CAB1331K	--	4
7, 8, 10	6, 8	CAB1331L	4	--
6	5	CAB112	2	--

Adapter sleeves can be used when a limited number of connections are to be made with a smaller conductor in a larger welder.



Magnetic Assembly B323N2

Powerful welding magnet securely positions the mold during the connection process to a flat steel surface or steel pipe. Helps with mold stability to reduce the chance of welding material leakage. Quickly and easily attaches to hold down "A" Price Key molds.

Tools and Materials

Extension Flint Ignitor

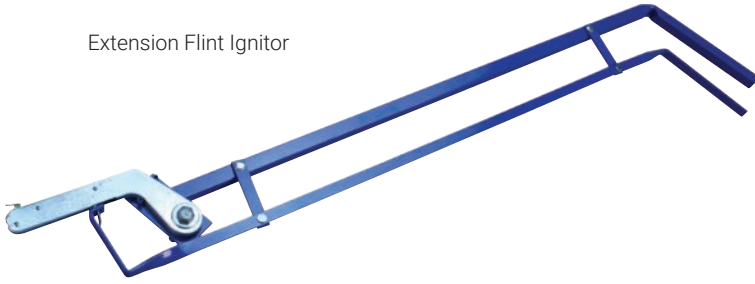

Lead Holding Clip

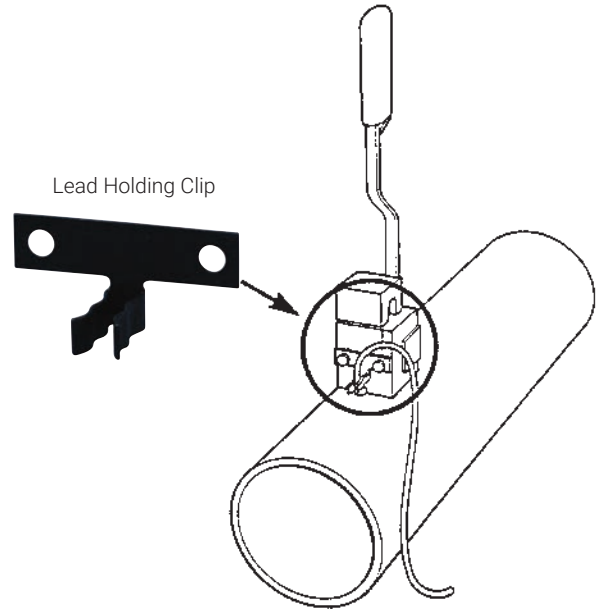

Cat. No.	Description
B32130	Extension including Flint Ignitor (30 inches long)
T320	Replacement Flint Ignitor Only
T320A	Replacement Flints
B322	Lead Holding Clip - Fits all CAA Price Welders

B319 Vertical Pipe Clamp

Holds the welder to a vertical pipe while the Cadweld connection is made. Fits all CAN, CAP or CAT price welders and pipes to 6 inches.

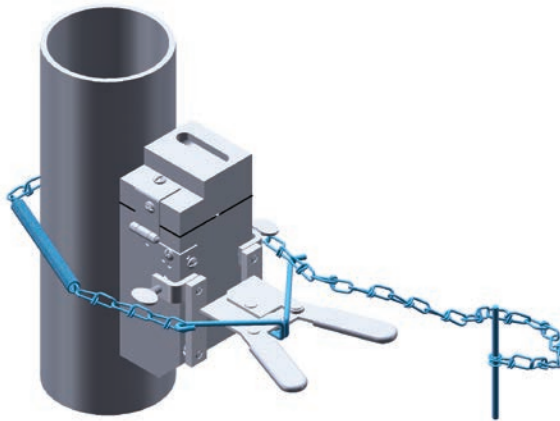

B320 Horizontal Pipe Clamp

Holds the welder to a horizontal pipe while the Cadweld connection is made. Fits all CAA price welders and pipes to 6 inches.

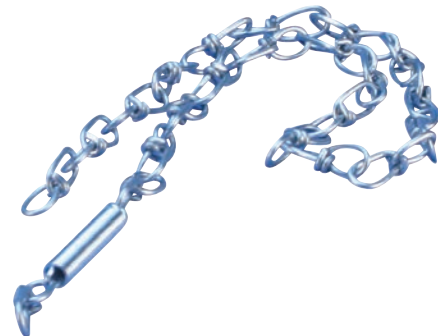

Tools and Materials

Tool Boxes And Tools

Item	Part No.
Cadweld Plus Impulse Exothermic Welding Control Unit	PLUSCU2L6
Tool boxes only	T396
Complete kit box and tools	T343 ¹
RASP	T321
Replacement blade for Rasp	T321A
Flint Ignitor	T320
Screw Driver	T305
Crimping Tool	T335
Disk Container	T328
Card Cloth Brush	T313
File and Handle	T329
Mold Sealer	T403

Tools also available separately.

¹ Uses tool box T396



PLUSCU2L6



T396



Brush

The **T313** Card Cloth Brush is used to clean all types of copper conductors. Its short stiff bristles provide for easy removal of oxides.



T321



T329



T320



T305



Mold Sealer

Mold Sealer is required around the cable on outside of the Cadweld mold for Types CAHA, CAHB, CAHC, and CAHE.



T328

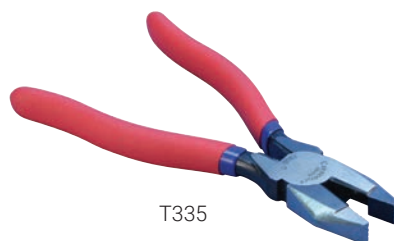

T335

T403 - 2# Package

Technical Information

PIPING CODE

Cadweld CONNECTIONS TO PIPELINES

1. The American Society of Mechanical Engineers* (ASME) publishes codes relating to the design and installation of pressure piping systems:
 - 1.1. ANSI/ASME B31.8- 2018, GAS TRANSMISSION AND DISTRIBUTION PIPING SYSTEMS.
 - 1.2. ANSI/ASME B31.4- 1998, LIQUID TRANSPORTATION SYSTEMS FOR HYDROCARBONS, LIQUID PETROLEUM GAS, ANHYDROUS AMMONIA, AND ALCOHOLS.
2. In both, under Corrosion Control, the standard allows the attachment of electrical leads using exothermic welding but limits the size of the weld metal used to:
 - 2.1. CA15 for steel pipe.[†]
 - 2.2. CA32XF19 for cast, wrought and ductile iron pipe.
3. These restrictions allow for the welding of #4 AWG and smaller wire to steel pipe using Cadweld Cathodic Type CAHA connections and #6 AWG and smaller to cast, wrought, and ductile iron using Type CAHB connections.

[†] Ref. ANSI/ASME B31.8 2018.

When larger sized conductors must be attached to pressure piping systems covered by these codes, several alternative solutions are available:

- 3.1. Using a Formed Terminal Bond (page 13), a #2 AWG can be welded to cast, wrought and ductile iron with a CA32XF19.
- 3.2. Using a Cadweld Bonding Strap (page 11), a 1/6" x 1" copper strip (equivalent to slightly smaller than a #1 AWG) can be welded to a cast, wrought and ductile iron pipe with a CA32XF19.
- 3.3. The "Punched Strap" Bond (page 12) (1/16" x 1-1/4" copper, equivalent to slightly less than a 1/0 AWG) can be welded to steel pipe using a CA15. The 5-hole model is used for "Dresser Type" couplings and the 2-hole model for standard joints.
- 3.4. The strands of a larger 7 strand conductor can be spread and each strand welded separately (figure 1) as noted in the following table:

* Available from: The American Society of Mechanical Engineers
United Engineering Center, 345 East 47th Street, New York, NY 10017.

Figure 1
Thermite welding of larger
7 STRAND cable to pipeline

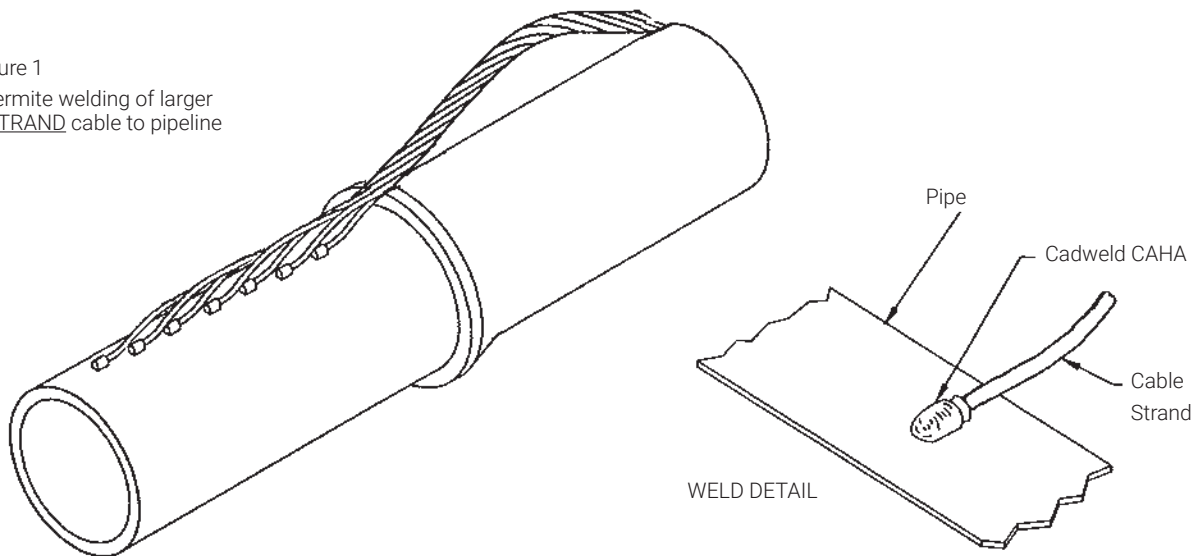

Conductor 7 Strand	Welder For Each Strand For Steel Pipe	Traditional Cadweld Weld Metal	Cadweld Plus Weld Metal
4/0	CAHAA1H	CA15	CA15PLUSF33
3/0 to #1	CAHAA1G	CA15	CA15PLUSF33
#2 to #4	CAHAA1G with sleeve CAB1331H	CA15	CA15PLUSF33

CADWELD CONNECTIONS AND PIPE WALL THICKNESS

The following is a discussion of the minimum pipe size required for safe installation of Cadweld Cathodic Connections considering of the service conditions and without special factory testing. Several things must be considered as outlined below.

For a particular wall thickness:

- a. The hoop stress in the pipe will increase as the pipe diameter increases.
- b. The heat dissipation will be affected by the thermal characteristics of the material in the pipe.
- c. The heat dissipation will be affected by the rate of flow of the material through the pipe while making the weld.
- d. The pipe strength will be affected by the temperature of the pipe (material temperature).
- e. Any internal coating of the pipe must be checked to find if the temperature of the pipe directly under the weld will adversely affect it.

Based on a minimum wall thickness of 0.109 inches* (2.769 mm) and using a CA15 Weld Metal (the maximum allowed to oil or gas piping systems per ANSI/ASME B31.4 and B31.8), the minimum recommended pipe size and schedule is:

Nominal Pipe Size	Schedule	Wall Thickness (inches)	Wall Thickness (mm)
1/2 inch	40	0.109	2.8
3/4 inch	40	0.113	2.9
1 to 2 inches	10	0.109	2.8
2 1/2 to 4 inch	10	0.120	3.0
5 to 8 inch	5	0.109	2.8
10 inch and larger	5	0.134 and above	3.4 and above

Tests made by operating gas companies indicate no damage to a 4" Grade 52 pipe having a 0.109" wall when making a weld to the pipe at 500 psig using a CA15. Welds made to a steel plate 0.109" thick had a maximum copper penetration depth of less than 0.010". Other tests on tubes with a 0.125" or 0.150" wall showed a copper penetration of 0.005" maximum.

DUCTILE IRON

Tests by nVent indicate that connections to DUCTILE IRON pipe can be made using the Cadweld molds and weld metal designated to be used on steel pipe.

However, some reports from the field suggest that all ductile iron is not the same. In some cases the material for steel will not work. In such cases, the molds and weld material for cast iron do work.

We therefore, suggest:

1. Whenever possible, make tests on the ductile iron pipe being used to determine if the material for steel can be used.

-OR-

2. Use the material for cast iron. It will make satisfactory connections on all ductile iron.

Cross Reference

Thermoweld Part Number	Cadweld Part Number
M100	CAHAA1G
M101	CAHAA1GA
M102	CAHAA1H
M103	CAHAA1HA
M104	CAHAA1K
M105	Call nVent
M106	CAHAA1L
M107	CAHAA1LA
M108	Call nVent
M109	CAHAA1T
M110	CAHAA1TA
M111	Call nVent
M112	CAHAA1V
M113	CAHAA1VA
M114	CAHAA1VA
M115	CAHAA1VB
M116	CAHAA1Y
M117	CAHAA1YA
M118	Call nVent
M119	Call nVent
M120	CAHAA2C
M121	CAHAA2CA
M122	Call nVent
M123	CAHAA2CC
M124	CAHAA2G
M125	Call nVent
M126	CAHAA2GB
M127	CAHGAA2GC
M142	CAVST1G
M150	CAVST1GA
M151	CAVST1GB
M144	CAVST1H
M152	CAVST1HA
M153	CAVST1HB
M145	CAVST1K
M186	CAVST1KA
M187	CAVST1KB
M188	CAVST1KC
M146	CAVST1L
M189	CAVST1LA
M190	CAVST1LB
M191	CAVST1LC
M147	CAVST1T
M192	CAVST1TA
M193	CAVST1TB
M194	CAVST1TC
M148	CAVST1V
M195	CAVST1VA
M196	CAVST1VB
M197	CAVST1VC
M198	CAVST1VD
M2586	CAVSP2C
M2587	CAVSP2CA
M2588	CAVSP2CB
M2589	CAVSP2CC
M2590	CAVSP2G
M2591	CAVSP2GA
M2592	CAVSP2GB
M2593	CAVSP2GC
M156	CAHBA1G

Thermoweld Part Number	Cadweld Part Number
M157	CAHBA1H
M158	CAHBA1K
M159	CAHBA1L
M160	CAHBA1T
M161	CAHBA1V
M162	Call nVent
M163	CAHBA1Y
M164	Call nVent
M165	Call nVent
M2594S	CAVHT1G
M2594	CAVHT1H
M2595S	CAVHT1K
M2595	CAVHT1L
M2596S	CAVHP1T
M2596	CAVHP1V
M2597S	Call nVent
M2597	CAVHP1Y
M2598	Call nVent
M2599	Call nVent
M1960	CAGRT151H
M1961	CAGRT151L
M1962	CAGRT151V
M1963	CAGRT151Y
M1964	CAGRT152C
M1965	CAGRT152G
M1968	CAGRT161H
M1969	CAGRT161L
M1970	CAGRP161V
M1971	CAGRP161Y
M1972	CAGRP162C
M1973	CAGRP162G
M1974	CAGRT181G
M1975	CAGRT181G
M1976	CAGRT181H
M1977	CAGRP181L
M1978	CAGRP181V
M1979	CAGRP181Y
M1980	CAGRP182C
M1981	CAGRP182G
M1982	CAGTT151G
M1983	CAGTT151G
M1984	CAGTT151H
M1985	CAGTT151L
M1986	CAGTP151V
M1987	CAGTP151Y
M1988	CAGTP152C
M1989	CAGTP152G
M1990	CAGTP161G
M1991	CAGTP161G
M1992	CAGTP161H
M1993	CAGTP161L
M1994	CAGTP161V
M1995	CAGTP161Y
M1996	CAGTN162C
M1997	CAGTN162G
M1998	CAGTP181G
M1999	CAGTP181G
M2000	CAGTP181H
M2001	CAGTP181L

Thermoweld Part Number	Cadweld Part Number
M2002	CAGTP181V
M2003	CAGTP181Y
M2004	CAGTN182C
M2005	CAGTN182G
M1927	CAPGT12CU
M1928	CAPGT10CU
M1929	CAPGT08CU
M1930	CAPGT06CU
M1931	CAPGT1G1D
M1932	CAPGT06CU
M1933	CAPGT1G1D
M1934	CAPGT1H1H
M1935	CAPGT1L1E
M1936	CAPGT1L1H
M1937	CAPGT1L1L
M1938	CAPGT1V1E
M1939	CAPGT1V1H
M1940	CAPGP1V1L
M1941	CAPGP1V1V
M1942	CAPGP1Y1E
M1943	CAPGP1Y1H
M1944	CAPGP1Y1L
M1945	CAPGP1Y1Y
M1946	CAPGP2C1E
M1947	CAPGP2C1H
M1948	CAPGP2C1L
M1949	CAPGP2C2C
M1950	CAPGP2G1E
M1951	CAPGP2G1H
M1952	CAPGP2G1L
M1953	CAPGN2G2G
15P	CA15
15PS	CA15S
25P	CA25
32P	CA32
45P	CA45
65P	CA65
15PCI	CA15XF19
25PCI	CA25XF19
32PCI	CA32XF19
45PCI	CA45XF19
65PCI	CA65XF19
A200	CAB1331H
A201	CAB1331L
A202	CAB112
A203	B1332C
A204	B1332L
A205	B1332Q
A206	B1332G
A304	CAT329
A305	CAT336
A306	CAT313
A309P	CAT320
A309PI	T320A
A320	B117A
B101	CAT321
B101P	CAT321A

Cadweld Applications

Buried Cast or Ductile Iron Pipelines

Secure your investment by specifying the Cadweld Process for Cathodic Protection connections. The Cadweld exothermic welding process produces a molecular bond to the surface of the pipe. Cadweld connections are permanent and ensure the highest degree of electrical continuity, eliminating the potential for corrosion problems.

Vertical Steel Applications

nVent makes Cathodic Protection easy for even the most difficult vertical steel applications. We offer a comprehensive line of magnetic clamps, attachments and tools specifically engineered for the challenges of vertical steel.

Reinforced Concrete Protection

Chloride contamination of reinforcing steel in concrete structures plagues many cold climate communities. To arrest corrosion, engineers specify Cathodic Protection systems for concrete road bridges and parking structures. Cadweld connections can be easily made to uneven surfaces of reinforcing steel rods for lasting protection.

Copper Cable Connections

Mechanical connections for electrical cable loosen and deteriorate with age. For superior performance, specify Cadweld exothermic connections to assure a permanent, molecular bond between connecting cables for full conductivity.





LIBERTY SALES & DISTRIBUTION



PHONE: (877) 373-0118
FAX: (888) 850-3787
EMAIL: sales@libertysales.net
WEB: www.libertysales.net